

# auta

## ANALOG

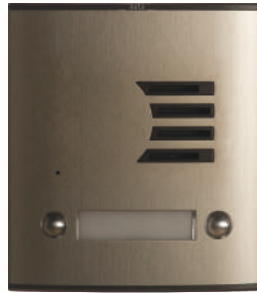

REF. 744302



REF. 744342



REF. 749702

ES KF-2 S1

EN KF-2 S1

PT KF-2 S1

FR KF-2 S1

# auta

Bringing people together

**Elementos en el kit** Elements in the kit

**ítems no kit** Éléments dans le kit



x1

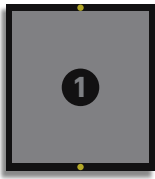

x1



x2

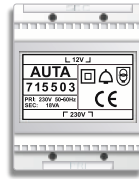

x1



x1

**Características** Features

**Caraterísticas** Caractéristiques

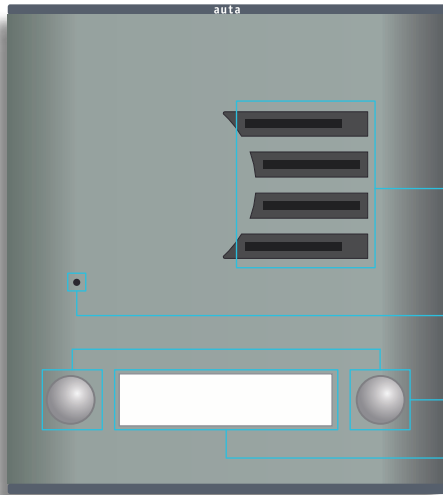

● **Altavoz** Alto-falante  
Speaker Haut-parleur

● **Micrófono** Microfone  
Microphone Microphone

● **Pulsadores de llamada** Botões de chamada  
Call push-buttons Boutons d'appel

● **Tarjetero de información** Cartão de informação  
Information cardholder Carte d'information

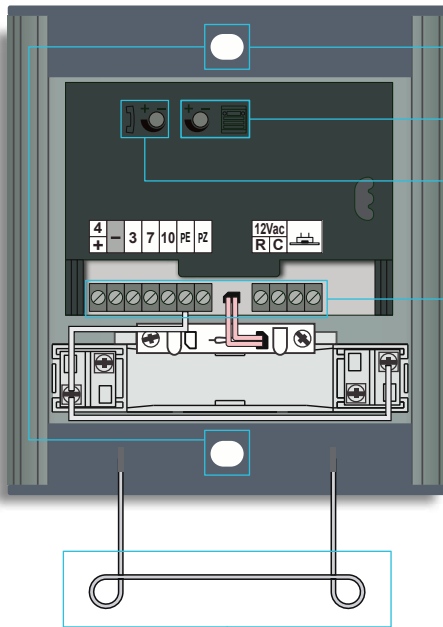

● **Orificios de fijación** Orifícios de fixação  
Placement holes Trous de fixation

● **Volumen de audio en placa** Volume de áudio a placa  
Panel audio volume Volume audio à panneau

● **Volumen de audio en vivienda** Volume de áudio na moradia  
Flat audio volume Volume audio dans le boîtier

● **Conexiones** Connections **Conexões** Les connexions

+	+9 Vcc (salida)	+9 Vdc (out)	+9 Vcc (sair)	+9 Vcc (sortir)
-	-9 Vcc (salida)	-9 Vdc (out)	-9 Vcc (sair)	-9 Vcc (sortir)
3	Micrófono	Microphone	Microfone	Microphone
7	Altavoz	Speaker	Alto-falante	Haut-parleur
10	Apertura	Opening	Abertura	Ouverture
PE	Sistema de llamada ELECTRÓNICA	ELECTRONIC call system	Sistema de chamada ELETRÔNICA	Système d'appel ÉLECTRONIQUE
PZ	Llamada ZUMBADOR	BUZZER call	Chamada BUZZER	Appel BUZZER
R	12 Vca (ALIMENTADOR)	12 Vac (SUPPLY)	12 Vca (ALIMENTADOR)	12 Vca (CHARGEUR)
C	12 Vca (ALIMENTADOR)	12 Vac (SUPPLY)	12 Vca (ALIMENTADOR)	12 Vca (CHARGEUR)
	Terminal 1, cerradura (12 Vca)	Terminal, 1 lock (12 Vac)	Terminal 1, trava (12 Vca)	Terminal 1, serrure (12 Vca)
	Terminal 2, cerradura (12 Vca)	Terminal 2, lock (12 Vac)	Terminal 2, trava (12 Vca)	Terminal 2, serrure (12 Vca)
	Alimentación LEDS (12 Vca)	LEDS supply (12 Vac)	Poder LEDS (12 Vca)	Puissance LEDS (12 Vca)

● **Soporte de apoyo para caja de empotrar**  
Hook support for mounting box

● **Supporte de supporte para caixa embutida**  
Support de supporte pour boîtier encastré

## Montaje Mounting

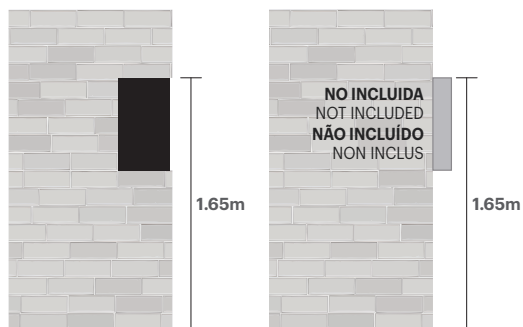

**Colocar caja de empotrar**  
Place mounting box  
**Coloque a caixa embutida**  
Placez la boîte encastrée

**Colocar caja de superficie**  
Place surface box  
**Coloque a caixa de superficie**  
Place surface box

1

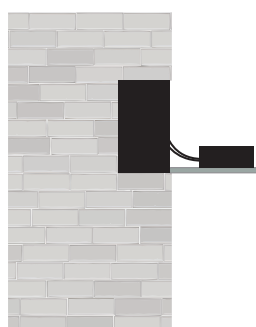

**Conectar el cableado**  
Connect the wiring  
**Conecte o cabos**  
Connecter le câblage

2



**Cerrar la placa realizando una curva inferior con el cableado**  
Connect the panel doing a lower curve with the wiring  
**Feche a placa fazendo uma curva mais baixa com a fiação**  
Fermer la plaque en faisant une courbe inférieure avec le câblage

3

## Colocar información en el tarjetero

Place information in the cardholder

## Coloque as informações no titular do cartão

Placez les informations dans le titulaire de la carte

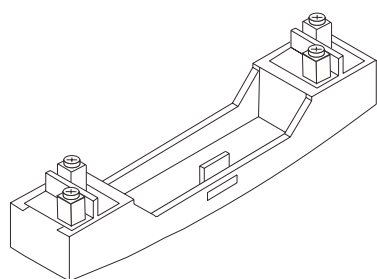

1

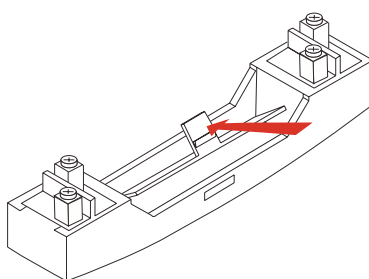

2

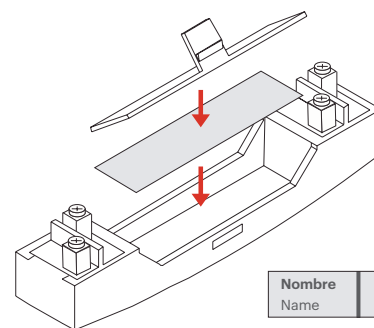

3

## Instalación Installation

## Instalação L'installation

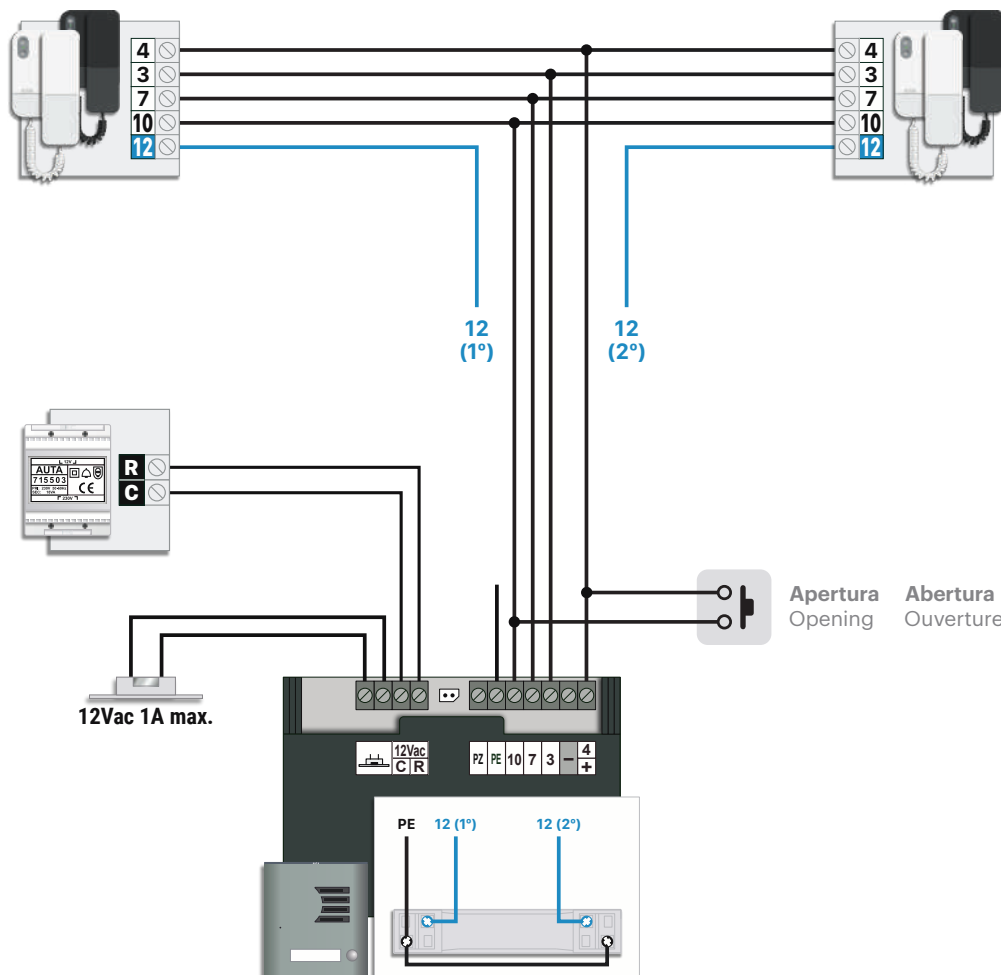

<b>ELEMENTOS</b> UNITS	<b>ATF-12</b> <b>(715503)</b>
 <b>LLAMADA SIMULTANEA</b> SIMULTANEOUS CALL	<b>2</b>

SECCIONES WIRING SECTIONS	HASTA 100m UP TO 100m	HASTA 200m UP TO 200m
<b>+4 3 7</b> <b>10 12</b>	<b>0.5mm</b> AWG20	<b>1mm</b> AWG17
<b>12 Vac</b> 	<b>1mm</b> AWG17	

**EL CABLEADO NO DEBE PASAR CERCA DE LA LINEA ELÉCTRICA**  
WIRING MUST NOT BE RUN CLOSE TO THE ELECTRICAL LINE